

<b>Operating instructions</b>	<b>en</b>
<b>Manual de instrucciones</b>	<b>es</b>
<b>Manual de instruções</b>	<b>pt</b>
<b>Brugsanvisning</b>	<b>da</b>
<b>Bruksanvisning</b>	<b>sv</b>
<b>Bruksanvisning</b>	<b>no</b>
<b>Käyttöohje</b>	<b>fi</b>
<b>Használati utasítás</b>	<b>hu</b>
<b>Návod k obsluze</b>	<b>cs</b>
<b>Návod na obsluhu</b>	<b>sk</b>
<b>Kullanma Talimatı</b>	<b>tr</b>
<b>دليل الاستعمال</b>	<b>ar</b>
<b>Lietošanas pamācība</b>	<b>lv</b>
<b>Instrukcija</b>	<b>lt</b>
<b>Kasutusjuhend</b>	<b>et</b>
<b>Пайдалану бойынша басшылық</b>	<b>kk</b>
<b>取扱説明書</b>	<b>ja</b>
<b>사용설명서</b>	<b>ko</b>
<b>操作説明書</b>	<b>zh</b>
<b>操作说明书</b>	<b>cn</b>

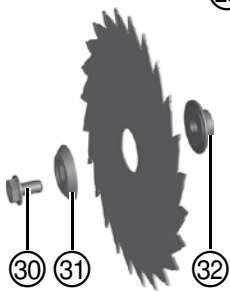

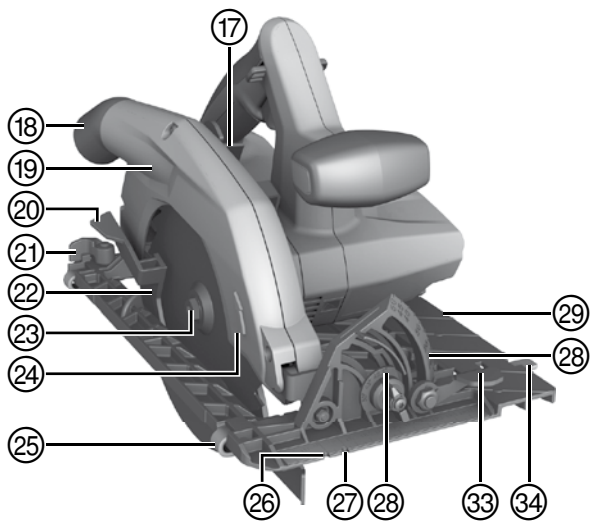
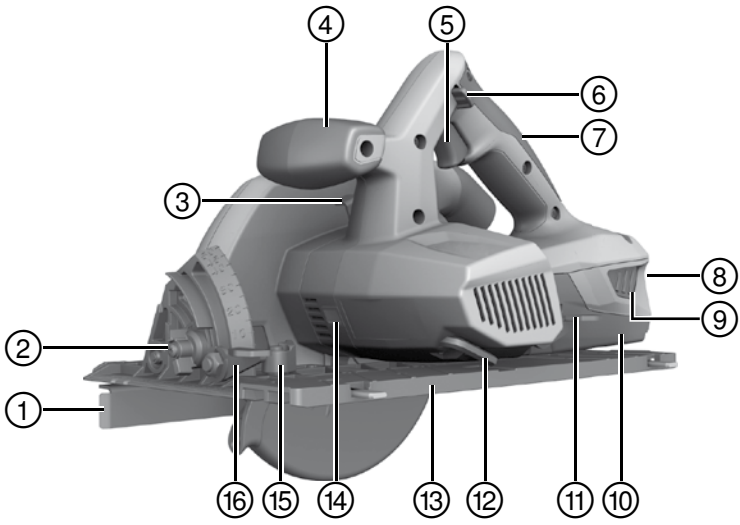
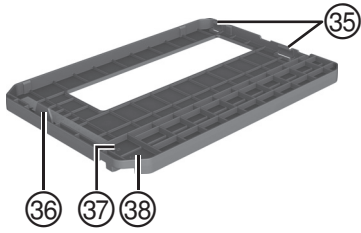
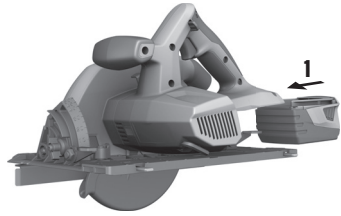
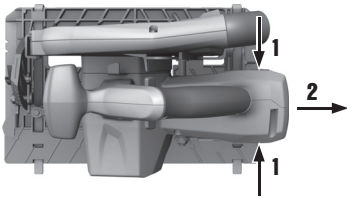
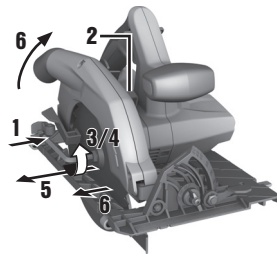
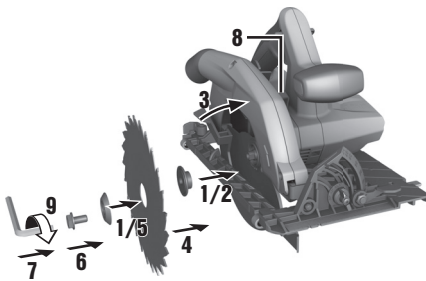
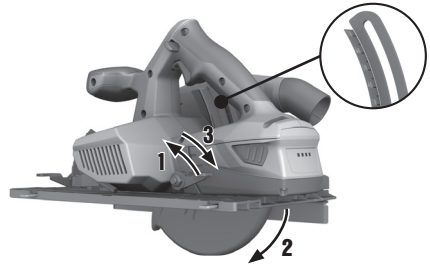
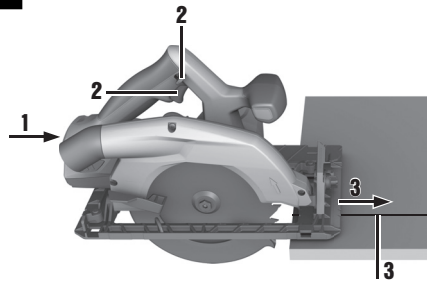

**2****3****4****5****6****7****8****9**

10

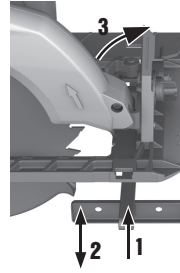
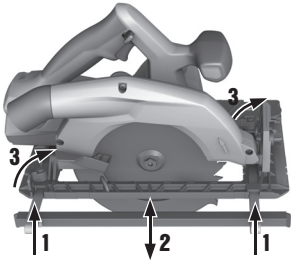

11

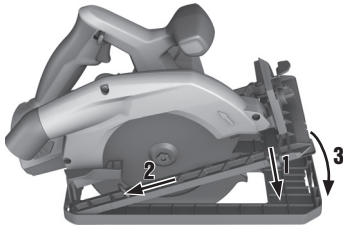

12

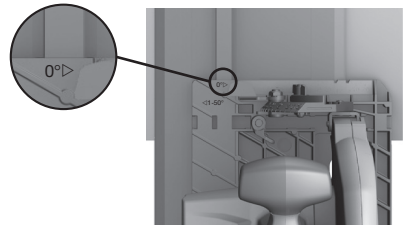

13

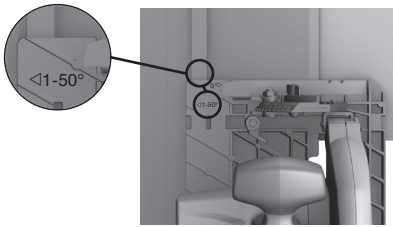

14

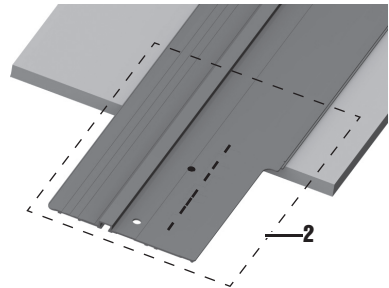
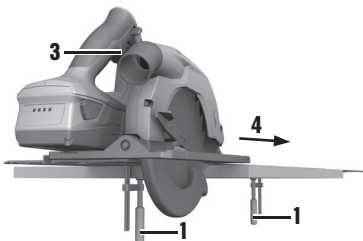

# ORIGINAL OPERATING INSTRUCTIONS

## SC 70W-A22 cordless circular saw

It is essential that the operating instructions are read before the power tool is operated for the first time.

Always keep these operating instructions together with the power tool.

Ensure that the operating instructions are with the power tool when it is given to other persons.

Contents	Page
1 General information	1
2 Safety instructions	2
3 Description	5
4 Accessories, consumables	6
5 Technical data	6
6 Before use	7
7 Operation	8
8 Care and maintenance	9
9 Troubleshooting	10
10 Disposal	11
11 Manufacturer's warranty - tools	11
12 EC declaration of conformity (original)	12

1 These numbers refer to the illustrations. You can find the illustrations at the beginning of the operating instructions.

In these operating instructions, the designation "the power tool" always refers to the SC 70W-A22 cordless circular saw.

### Operating controls and indicators 1

- 1 Single-arm parallel guide (rip fence)
- 2 Cutting angle presets (22.5°, 45°, 50°)
- 3 Drive spindle lockbutton

- 4 Auxiliary grip
- 5 On / off switch
- 6 Switch-on interlock
- 7 Grip
- 8 Charge status and fault display (Li-ion battery)
- 9 Release buttons with additional function (charge status display activation)
- 10 Battery
- 11 Clamping lever for cutting depth adjustment
- 12 Hexagon socket wrench
- 13 Small base plate
- 14 LED illumination
- 15 Front clamping lever for the parallel guide
- 16 Clamping lever for cutting angle adjustment
- 17 Cutting depth scale
- 18 Hose connector (chip deflector)
- 19 Guard
- 20 Pivoting guard operating lever
- 21 Rear clamping lever for the parallel guide (only with large base plate)
- 22 Pivoting guard
- 23 Drive spindle
- 24 Direction-of-rotation arrow
- 25 Twin-arm parallel guide (rip fence)
- 26 0° cutting line indicator
- 27 45° cutting line indicator
- 28 Cutting angle scale
- 29 Large base plate
- 30 Clamping screw
- 31 Clamping flange
- 32 Mounting flange
- 33 0° indicator on the base plate
- 34 1°- 50° indicator on the base plate

### Guide rail adapter 2

- 35 Rear retaining lug
- 36 Front retaining lug
- 37 0° indicator
- 38 1°- 50° indicator

## 1 General information

### 1.1 Safety notices and their meaning

#### DANGER

Draws attention to imminent danger that will lead to serious bodily injury or fatality.

#### WARNING

Draws attention to a potentially dangerous situation that could lead to serious personal injury or fatality.

#### CAUTION

Draws attention to a potentially dangerous situation that could lead to slight personal injury or damage to the equipment or other property.

#### NOTE

Draws attention to an instruction or other useful information.

## 1.2 Explanation of the pictograms and other information

### Warning signs



General warning



Warning: caustic substances

### Obligation signs



Read the operating instructions before use.

## Symbols

$n_0$



Rated speed under no load

Saw blade

### Location of identification data on the power tool

The type designation and serial number can be found on the type identification plate on the machine or tool. Make a note of this data in your operating instructions and always refer to it when making an enquiry to your Hilti representative or service department.

Type: \_\_\_\_\_

Generation: 01 \_\_\_\_\_

Serial no.: \_\_\_\_\_

## 2 Safety instructions

### NOTE

The safety rules in section 2.1 contain all general safety rules for power tools which, in accordance with the applicable standards, must be listed in the operating instructions. Accordingly, some of the rules listed may not be relevant to this tool.

### 2.1 General power tool safety warnings

#### a) WARNING

**Read all safety warnings and all instructions.** Failure to follow the warnings and instructions may result in electric shock, fire and/or serious injury. **Save all warnings and instructions for future reference.** The term “power tool” in the warnings refers to your mains-operated (corded) power tool or battery-operated (cordless) power tool.

#### 2.1.1 Work area safety

- Keep work area clean and well lit.** Cluttered or dark areas invite accidents.
- Do not operate power tools in explosive atmospheres, such as in the presence of flammable liquids, gases or dust.** Power tools create sparks which may ignite the dust or fumes.
- Keep children and bystanders away while operating a power tool.** Distractions can cause you to lose control.

#### 2.1.2 Electrical safety

- Power tool plugs must match the outlet. Never modify the plug in any way. Do not use any adapter plugs with earthed (grounded) power tools.**

Unmodified plugs and matching outlets will reduce risk of electric shock.

- Avoid body contact with earthed or grounded surfaces, such as pipes, radiators, ranges and refrigerators.** There is an increased risk of electric shock if your body is earthed or grounded.
- Do not expose power tools to rain or wet conditions.** Water entering a power tool will increase the risk of electric shock.
- Do not abuse the cord. Never use the cord for carrying, pulling or unplugging the power tool. Keep cord away from heat, oil, sharp edges or moving parts.** Damaged or entangled cords increase the risk of electric shock.
- When operating a power tool outdoors, use an extension cord suitable for outdoor use.** Use of a cord suitable for outdoor use reduces the risk of electric shock.
- If operating a power tool in a damp location is unavoidable, use a residual current device (RCD) protected supply.** Use of an RCD reduces the risk of electric shock.

#### 2.1.3 Personal safety

- Stay alert, watch what you are doing and use common sense when operating a power tool. Do not use a power tool while you are tired or under the influence of drugs, alcohol or medication.** A moment of inattention while operating power tools may result in serious personal injury.
- Use personal protective equipment. Always wear eye protection.** Protective equipment such as dust mask, non-skid safety shoes, hard hat, or hearing

protection used for appropriate conditions will reduce personal injuries.

- c) **Prevent unintentional starting. Ensure the switch is in the off-position before connecting to power source and/or battery pack, picking up or carrying the tool.** Carrying power tools with your finger on the switch or energising power tools that have the switch on invites accidents.
- d) **Remove any adjusting key or wrench before turning the power tool on.** A wrench or a key left attached to a rotating part of the power tool may result in personal injury.
- e) **Do not overreach. Keep proper footing and balance at all times.** This enables better control of the power tool in unexpected situations.
- f) **Dress properly. Do not wear loose clothing or jewellery. Keep your hair, clothing and gloves away from moving parts.** Loose clothes, jewellery or long hair can be caught in moving parts.
- g) **If devices are provided for the connection of dust extraction and collection facilities, ensure these are connected and properly used.** Use of dust collection can reduce dust-related hazards.

#### 2.1.4 Power tool use and care

- a) **Do not force the power tool. Use the correct power tool for your application.** The correct power tool will do the job better and safer at the rate for which it was designed.
- b) **Do not use the power tool if the switch does not turn it on and off.** Any power tool that cannot be controlled with the switch is dangerous and must be repaired.
- c) **Disconnect the plug from the power source and/or the battery pack from the power tool before making any adjustments, changing accessories, or storing power tools.** Such preventive safety measures reduce the risk of starting the power tool accidentally.
- d) **Store idle power tools out of the reach of children and do not allow persons unfamiliar with the power tool or these instructions to operate the power tool.** Power tools are dangerous in the hands of untrained users.
- e) **Maintain power tools. Check for misalignment or binding of moving parts, breakage of parts and any other condition that may affect the power tool's operation. If damaged, have the power tool repaired before use.** Many accidents are caused by poorly maintained power tools.
- f) **Keep cutting tools sharp and clean.** Properly maintained cutting tools with sharp cutting edges are less likely to bind and are easier to control.
- g) **Use the power tool, accessories and tool bits etc. in accordance with these instructions, taking into account the working conditions and the work to be performed.** Use of the power tool for operations different from those intended could result in a hazardous situation.

#### 2.1.5 Battery tool use and care

- a) **Recharge only with the charger specified by the manufacturer.** A charger that is suitable for one type of battery pack may create a risk of fire when used with another battery pack.
- b) **Use power tools only with specifically designated battery packs.** Use of any other battery packs may create a risk of injury and fire.
- c) **When battery pack is not in use, keep it away from other metal objects, like paper clips, coins, keys, nails, screws or other small metal objects, that can make a connection from one terminal to another.** Shorting the battery terminals together may cause burns or a fire.
- d) **Under abusive conditions, liquid may be ejected from the battery; avoid contact. If contact accidentally occurs, flush with water. If liquid contacts eyes, additionally seek medical help.** Liquid ejected from the battery may cause irritation or burns.

#### 2.1.6 Service

- a) **Have your power tool serviced by a qualified repair person using only identical replacement parts.** This will ensure that the safety of the power tool is maintained.

### 2.2 Safety instructions for all saws

#### 2.2.1 Cutting procedures

- a)  **DANGER**  
**Keep hands away from cutting area and the blade. Keep your second hand on auxiliary handle, or motor housing.** If both hands are holding the saw, they cannot be cut by the blade.
- b) **Do not reach underneath the workpiece.** The guard cannot protect you from the blade below the workpiece.
- c) **Adjust the cutting depth to the thickness of the workpiece.** Less than a full tooth of the blade teeth should be visible below the workpiece.
- d) **Never hold piece being cut in your hands or across your leg. Secure the workpiece to a stable platform.** It is important to support the work properly to minimize body exposure, blade binding, or loss of control.
- e) **Hold the power tool by insulated gripping surfaces only, when performing an operation where the cutting tool may contact hidden wiring.** Contact with a "live" wire will also make exposed metal parts of the power tool "live" and could give the operator an electric shock.
- f) **When ripping, always use a rip fence or straight edge guide.** This improves the accuracy of cut and reduces the chance of blade binding.
- g) **Always use blades with correct size and shape (diamond versus round) of arbour holes.** Blades that do not match the mounting hardware of the saw will run eccentrically, causing loss of control.

- h) **Never use damaged or incorrect blade washers or bolt.** The blade washers and bolt were specially designed for your saw, for optimum performance and safety of operation.

## 2.2.2 Further safety instructions for all saws

en

### Kickback causes and related warnings

Kickback is a sudden reaction to a pinched, bound or misaligned saw blade, causing an uncontrolled saw to lift up and out of the workpiece toward the operator; when the blade is pinched or bound tightly by the kerf closing down, the blade stalls and the motor reaction drives the unit rapidly back toward the operator; if the blade becomes twisted or misaligned in the cut, the teeth at the back edge of the blade can dig into the top surface of the wood causing the blade to climb out of the kerf and jump back toward the operator.

Kickback is the result of saw misuse and/or incorrect operating procedures or conditions and can be avoided by taking proper precautions as given below.

- a) **Maintain a firm grip with both hands on the saw and position your arms to resist kickback forces. Position your body to either side of the blade, but not in line with the blade.** Kickback could cause the saw to jump backwards, but kickback forces can be controlled by the operator, if proper precautions are taken.
- b) **When blade is binding, or when interrupting a cut for any reason, release the trigger and hold the saw motionless in the material until the blade comes to a complete stop. Never attempt to remove the saw from the work or pull the saw backward while the blade is in motion or kickback may occur.** Investigate and take corrective actions to eliminate the cause of blade binding.
- c) **When restarting a saw in the workpiece, centre the saw blade in the kerf and check that saw teeth are not engaged into the material.** If saw blade is binding, it may walk up or kickback from the workpiece as the saw is restarted.
- d) **Support large panels to minimise the risk of blade pinching and kickback.** Large panels tend to sag under their own weight. Supports must be placed under the panel on both sides, near the line of cut and near the edge of the panel.
- e) **Do not use dull or damaged blades.** Unsharpened or improperly set blades produce narrow kerf causing excessive friction, blade binding and kickback.
- f) **Blade depth and bevel adjusting locking levers must be tight and secure before making cut.** If blade adjustment shifts while cutting, it may cause binding and kickback.
- g) **Use extra caution when sawing into existing walls or other blind areas.** The protruding blade may cut objects that can cause kickback.

## 2.2.3 Safety instructions for circular saws with pendulum guard

### Lower guard function

- a) **Check lower guard for proper closing before each use. Do not operate the saw if lower guard does not move freely and close instantly. Never clamp or tie the lower guard into the open position.** If saw is accidentally dropped, lower guard may be bent. Raise the lower guard with the retracting handle and make sure it moves freely and does not touch the blade or any other part, in all angles and depths of cut.
- b) **Check the operation of the lower guard spring. If the guard and the spring are not operating properly, they must be serviced before use.** Lower guard may operate sluggishly due to damaged parts, gummy deposits, or a build-up of debris.
- c) **Lower guard may be retracted manually only for special cuts such as "plunge cuts" and "compound cuts."** Raise lower guard by retracting handle and as soon as blade enters the material, the lower guard must be released. For all other sawing, the lower guard should operate automatically.
- d) **Always observe that the lower guard is covering the blade before placing saw down on bench or floor.** An unprotected, coasting blade will cause the saw to walk backwards, cutting whatever is in its path. Be aware of the time it takes for the blade to stop after switch is released.

## 2.3 Additional safety instructions

### 2.3.1 Personal safety

- a) **Modification of the machine or tampering with its parts is not permissible.**
- b) **Wear ear protectors.** Exposure to noise can cause hearing loss.
- c) **Breathing protection must be worn if the power tool is used without a dust removal system for work that creates dust.**
- d) **Do not operate the power tool without the protective devices that belong to it.**
- e) **Improve the blood circulation in your fingers by relaxing your hands and exercising your fingers during breaks between working.**
- f) **Switch the power tool on only after bringing it into position at the workpiece.**
- g) **Remove the battery before storing or transporting the tool.**
- h) **Always guide the power tool away from your body when working with it.**
- i) **Do not work with the power tool overhead.**
- j) **Do not attempt to brake the speed of the saw blade by pressing it laterally against the workpiece or some other object.**
- k) **Do not touch the clamping flange, the clamping screw or the saw blade while the power tool is running.**
- l) **The kerf must be free of obstructions. Do not saw into screws and nails etc.**
- m) **Never press the drive spindle lockbutton while the saw blade is rotating.**
- n) **Never direct the power tool toward persons.**



- o) The appliance is not intended for use by debilitated persons who have received no special training. Keep the appliance out of reach of children.
- p) Adjust the pressure applied to the saw blade and the material being cut so that the blade does not stall, possibly causing the power tool to kick back.
- q) Avoid overheating the tips of the saw blade teeth.
- r) When cutting plastics, melting of the plastic should be avoided.
- s) Working on the material may cause it to splinter. **Wear eye protection and protective gloves. Wear breathing protection if no dust removal system is used.** Splintering material presents a risk of injury to the eyes and body.
- t) **Before beginning the work, check the hazard classification of the dust that will be produced. Use an industrial vacuum cleaner with an officially approved protection classification in compliance with locally applicable dust protection regulations.**
- u) Dust from materials, such as paint containing lead, some wood species, concrete / masonry / stone containing silica, and minerals as well as metal, may be harmful. Contact with or inhalation of the dust may cause allergic reactions and/or respiratory or other diseases to the operator or bystanders. Certain kinds of dust are classified as carcinogenic such as oak and beech dust, especially in conjunction with additives for wood conditioning (chromate, wood preservative). Material containing asbestos must only be treated by specialists. **Where the use of a dust-extraction device is possible it shall be used. To achieve a high level of dust collection, use a suitable dust extractor. When indicated wear a respirator ap-**

- appropriate for the type of dust generated. Ensure that the workplace is well ventilated. Follow national requirements for the materials you want to work with.
- v) The cutting depth set should always be approx. 5 to 10 mm greater than the thickness of the material to be cut.

**2.3.2 Electrical safety**

**Before beginning work, check the working area (e.g. using a metal detector) to ensure that no concealed electric cables or gas and water pipes are present.** External metal parts of the power tool may become live, for example, when an electric cable is damaged accidentally. This presents a serious risk of electric shock.

**2.3.3 Careful handling and use of batteries**

- a) **Observe the special guidelines applicable to the transport, storage and use of Li-ion batteries.**
- b) **Do not expose batteries to high temperatures and keep them away from fire.** This presents a risk of explosion.
- c) **Do not disassemble, squash or incinerate batteries and do not subject them to temperatures over 80°C.** This presents a risk of fire, explosion or injury through contact with caustic substances.
- d) **Do not charge or continue to use damaged batteries (e.g. batteries with cracks, broken parts, bent or pushed-in and/or pulled-out contacts).**
- e) If the battery gets hot while not in use, the battery or the power tool/battery system may be defective. **Put the power tool/battery system in a suitable place where it is an adequate distance from flammable materials. Keep the system under observation while it is cooling down and contact Hilti Service.**

**3 Description**

**3.1 Use of the product as directed**

The power tool is a hand-held, cordless circular saw. The power tool is designed for cutting flat-surfaced wood or wood-like materials, plastics, gypsum plasterboard, gypsum fiberboard and composites up to a cutting depth of 70 mm and for making bevel cuts at angles between 0° and 50°.

The power tool is designed for professional use and may be operated, serviced and maintained only by trained, authorized personnel. This personnel must be informed of any special hazards that may be encountered. The power tool and its ancillary equipment may present hazards when used incorrectly by untrained personnel or when used not as directed.

Observe the national health and safety requirements.

Use of saw blades not in compliance with the given specification (e.g. diameter, speed of rotation, thickness) or use of cutting and grinding discs or blades made from high-alloy steel (HSS steel) is not permissible due to risk of breakage. Sawing metals is not permissible.

Do not use the battery as a power source for other unspecified appliances.

To avoid the risk of injury, use only genuine Hilti accessories and insert tools.

**3.2 Standard equipment includes:**

- 1 Power tool
- 1 Saw blade
- 1 Operating instructions

- 1 Hexagon socket wrench
- 1 Rip fence (parallel guide)
- 1 Guide rail adapter (optional)

### 3.3 Additional items required for operating the tool:

A suitable battery of the specified type (see table in the Technical Data section) and a suitable battery charger from the C 436 series. For further information about battery charging, please read the operating instructions for the battery charger.

### 3.4 Lithium-ion battery charge status

The Li-ion battery features a charge status display. The charge status is indicated by the LEDs on the battery during charging (please refer to the operating instructions for the charger). When the battery is not in use, pressing one of the battery release buttons or inserting the battery into the power tool causes the battery charge status to be displayed by the four LEDs for three seconds.

LEDs light constantly	LEDs blink	Charge status C
LED 1, 2, 3, 4	-	$C \geq 75 \%$
LED 1, 2, 3	-	$50 \% \leq C < 75 \%$
LED 1, 2	-	$25 \% \leq C < 50 \%$
LED 1	-	$10 \% \leq C < 25 \%$
-	LED 1	$C < 10 \%$

#### NOTE

Indication of the charge status is not possible while the power tool is in operation or immediately after operation. If the battery charge status LEDs flash, please refer to the information given in section 9. "Troubleshooting".

## 4 Accessories, consumables

#### NOTE

Accessories can be found at your Hilti Center or online at [www.hilti.com](http://www.hilti.com).

#### Spare parts

Designation
Mounting flange
Clamping flange
Clamping screw

## 5 Technical data

Right of technical changes reserved.

Power tool	SC 70W-A22
Rated voltage (DC voltage)	21.6 V
Weight in accordance with EPTA procedure 01/2003, with large base plate	4.7 kg
Weight in accordance with EPTA procedure 01/2003, with small base plate	4.5 kg
Specified blade diameter	190 mm
Saw blade disc thickness	0.7 ... 1.5 mm
Saw blade arbor size	30 mm

<b>Power tool</b>	<b>SC 70W-A22</b>
Cutting depth with scale setting	Bracket 0°: 70 mm Bracket 45°: 51 mm Bracket 50°: 45 mm
Speed under no load	3,500/min

**NOTE**

The sound pressure and vibration values given in these instructions have been measured in accordance with a standardized test and may be used to compare one electric tool with another. They may be used for a preliminary assessment of exposure. The data given represents the main applications of the electric tool. However, if the electric tool is used for different applications, with different accessories or is poorly maintained, the data may vary. This may significantly increase exposure over the total working period. An accurate estimation of exposure should also take into account the times when the tool is switched off, or when it is running but not actually being used for a job. This may significantly reduce exposure over the total working period. Identify additional safety measures to protect the operator from the effects of noise and/or vibration, for example: maintain the electric tool and accessories, keep the hands warm, organisation of work patterns.

**Noise and vibration information for the SC 70W-A22 (measured in accordance with EN 60745-2-5):**

Typical A-weighted sound power level, $L_{WA}$	92 dB (A)
Typical A-weighted emission sound pressure level, $L_{pA}$	81 dB (A)
Uncertainty for the given sound level, K	3 dB (A)

**Triaxial vibration values (vibration vector sum)**

Sawing in wood, $a_{hW}$	1.3 m/s <sup>2</sup>
Uncertainty (K)	1.5 m/s <sup>2</sup>

<b>Battery</b>	<b>B 22/5.2 Li-Ion (01)</b>	<b>B 22/3.3 Li-Ion</b>	<b>B 22/2.6 Li-Ion (02)</b>
Rated voltage	21.6 V	21.6 V	21.6 V
Capacity	5.2 Ah	3.3 Ah	2.6 Ah
Weight	0.78 kg	0.78 kg	0.48 kg

**6 Before use****NOTE**

The system switches itself off automatically when the battery voltage is low.

**NOTE**

Read the operating instructions for the charger for further information about the charging procedure.

**6.1 Inserting the battery 3****CAUTION**

**Check that the power tool is switched off and the switch interlock activated before fitting the battery.**

**CAUTION**

**Before inserting the battery in the power tool, check to ensure that the battery terminals and the contacts in the power tool are free from foreign objects.**

**CAUTION**

**A falling battery may present a risk of injury to yourself and others.**

**NOTE**

Check that the battery is securely seated in the tool.

**6.2 Removing the battery from the power tool 4****6.3 Transport and storage of batteries****CAUTION**

Fire hazard. Never transport batteries in loose, bulk form. There is a risk of short circuiting.

Pull the battery out of the locked position (working position) and move it into the first latching position (transport position).

Observe national and international transport regulations when shipping batteries (transportation by road, rail, sea or air).

## 7 Operation

### NOTE

If the blade has jammed, the tool will not restart by itself when the pressure applied to it is removed. The switch-on interlock and the on/off button must be pressed again.

### DANGER

**Remove the battery from the power tool before making any adjustments, before changing accessories and before storing the power tool.** Such preventive safety measures reduce the risk of starting the tool accidentally.

### DANGER

**Do not switch the power tool on if the saw blade, the blade guard or the pivoting guard are not fitted correctly.**

### CAUTION

**Check all safety devices each time before using the saw.** Open the pivoting guard fully and check that the guard automatically returns to the fully closed position when released. Clean the pivoting guard if necessary or have the power tool repaired by Hilti Service if it malfunctions.

#### 7.1 Changing the saw blade

### CAUTION

**Wear protective gloves when changing saw blades.** The saw blade, clamping flange and clamping screw get hot and the cutting edges of the saw blade are sharp.

### CAUTION

**Check that the blade to be fitted complies with the technical requirements and that it is well sharpened.** A sharp saw blade is an essential requirement for a perfect cut.

#### 7.1.1 Removing the saw blade 5

1. Insert the hex. socket wrench in the saw blade clamping screw.
2. Press the drive spindle lockbutton and hold it in this position.
3. Turn the saw blade clamping screw with the hex. socket wrench until the spindle lockbutton engages fully.
4. Release the clamping screw by turning the hex. socket wrench further in the direction of the direction-of-rotation arrow.
5. Remove the clamping screw from the outer clamping flange.
6. Open the pivoting guard by swinging it to the side and then remove the saw blade.

**NOTE** If necessary, the mounting flange can be removed for cleaning.

#### 7.1.2 Fitting the saw blade 6

1. Clean the mounting flange and the clamping flange.
2. Fit the mounting flange onto the drive spindle the right way round.

3. Open the pivoting guard.
4. **CAUTION Observe the direction-of-rotation arrow on the saw blade and on the power tool. They must correspond.**  
Fit the new saw blade.
5. Fit the outer clamping flange the right way round.
6. Insert the clamping screw.
7. Insert the hex. socket wrench in the saw blade clamping screw.
8. Press the drive spindle lockbutton.
9. Secure the clamping flange with the clamping screw by turning the hex. socket wrench in the opposite direction to the direction-of-rotation arrow.  
The spindle lockbutton engages as you do so.
10. Before using the power tool, check that the saw blade is correctly seated and tightened securely.

#### 7.2 Adjusting the cutting depth 7

### NOTE

The cutting depth set should always be approx. 5 to 10 mm greater than the thickness of the material to be cut.

### NOTE

The depth setting can be read from the scale and pointer at the rear of the blade guard.

#### 7.3 Adjusting the cutting angle 8

The cutting angle preset makes it easy to set the maximum angle (22.5°, 45°, 50°).

1. Release the cutting angle adjustment clamping lever.
2. Pivot the base plate to the 0° position.
3. Set the preset angle pointer to the desired maximum angle.
4. Pivot the base plate to the desired angle.
5. Tighten the cutting angle adjustment clamping lever.

#### 7.4 Sawing along a line 9

### NOTE

Secure the workpiece to prevent movement.

### NOTE

Position the workpiece so that the saw blade is free to rotate beneath it.

### NOTE

Check to ensure that the on / off switch on the power tool is in the "off" position.

### NOTE

Position the forward section of the saw's base plate on the workpiece but do not bring the blade into contact with the workpiece.

1. Fit the battery into the power tool.
2. If the switch-on interlock has been pressed, switch the power tool on by pressing the on/off button.
3. Guide the saw along the cutting line on the workpiece at a suitable speed.

### 7.5 Fitting and using the parallel guide (rip fence)

The rip fence (parallel guide) can be used to make accurate cuts along the edge of a workpiece or to cut strips of equal width.

The parallel guide (single-arm/twin-arm) can be fitted on either side of the base plate. The twin-arm parallel guide can be used only with the large base plate.

### 7.6 Using the saw on the guide rail

#### NOTE

When using a saw with a small base plate, please use a guide rail adapter that fits the guide rail.

### 7.6.1 Fitting or removing the saw from the guide rail adapter (small base plate)

The parallel guide (rip fence) must be removed before the guide rail adapter can be used.

To remove the saw, pull the front retaining lug forward slightly and lift the saw up out of the guide rail adapter.

### 7.6.2 Longitudinal cuts at 0°

Place the saw on the guide rail with the groove marked "0°" on the rib on the rail.

### 7.6.3 Longitudinal cuts at angles of 1° - 50°

#### CAUTION

The saw must be engaged in the correct groove. If the saw is engaged in the wrong groove, the saw blade will collide with the guide rail.

Place the saw on the guide rail with the groove marked "1° - 50°" on the rib on the rail.

### 7.7 Using the saw on the guide rail

1. Secure the guide rail from below with two screw clamps.

**NOTE** The saw must be placed on the guide rail in the area before the workpiece.

2. **CAUTION Take care to ensure that the saw blade is not in contact with the workpiece.**

Place the saw on the guide rail in the saw mounting area of the rail (a short distance before the starting point of the cut).

3. Switch the power tool on.
4. Push the saw steadily across the workpiece. The pivoting guard opens as it contacts the actuating edge at the side of the guide rail and subsequently closes at the end of the rail as the cut is completed.

### 7.8 Using the saw with a dust and chip removal system

The circular saw is equipped with a hose connector suitable for use with common types of vacuum cleaner hose. In order to connect the vacuum cleaner hose to the saw, use of a suitable adapter may be necessary.

### 7.9 Using the saw without a dust and chip removal system

Check that the sawdust is ejected without obstruction. If necessary, the direction of ejection can be altered by turning the hose connector.

### 7.10 Procedure when sawdust channel is blocked

1. Remove the battery from the power tool.
2. Clean the chip / dust channel. **NOTE** Remove the saw blade if necessary.
3. Check for misalignment or binding of moving parts, breakage of parts and any other condition that may affect the power tool's operation.

## 8 Care and maintenance

### WARNING

**Repairs to the electrical section of the power tool may be carried out only by trained electrical specialists.**

### 8.1 Care of the power tool

#### CAUTION

**Keep the power tool, especially its grip surfaces, clean and free from oil and grease. Do not use cleaning agents which contain silicone.**

Never operate the power tool when the ventilation slots are blocked. Clean the ventilation slots carefully using a dry brush. Do not permit foreign objects to enter the interior of the power tool. Clean the outside of the power tool at regular intervals with a slightly damp cloth. Do

not use a spray, steam pressure cleaning equipment or running water for cleaning. This may negatively affect the electrical safety of the power tool.

### 8.2 Cleaning the safety devices

1. Remove the saw blade before cleaning the safety devices.
2. Clean the safety devices carefully with a dry brush.
3. Use a suitable tool to remove deposits or wood chips from the inside surfaces of the safety devices.
4. Fit the saw blade.

### 8.3 Care of the Li-ion battery

#### NOTE

Battery performance drops at low temperatures.

#### NOTE

Store the battery in a cool and dry place.

In order to achieve maximum battery life, stop using the battery as soon as a significant drop in battery performance is noticed.

#### NOTE

- If use continues, further battery discharge will be stopped automatically before the battery cells suffer damage.
- Charge the batteries using the specified and approved Hilti battery chargers for Li-ion batteries.

### 8.4 Checking the power tool after care and maintenance

After carrying out care and maintenance work on the power tool, check that all protective and safety devices are fitted and that they function faultlessly.

To check the pivoting guard, open the guard fully by moving the guard operating lever.

The pivoting guard must close quickly and completely when the guard operating lever is released.

## 9 Troubleshooting

Fault	Possible cause	Remedy
The power tool doesn't run.	The battery is discharged or is not pushed all the way in.	The battery must be heard to engage with a double click or, respectively, needs to be charged.
	Electrical fault.	Remove the battery from the tool and contact Hilti Service.
The power tool doesn't run. The LED blinks.	The battery is discharged.	Charge the battery.
	The battery is hot.	Insert the battery in the charger or allow it to cool down.
The on/off button cannot be pressed, i.e. the button is locked.	Not a fault (safety function).	Press the switch-on interlock.
Running speed suddenly drops considerably.	The battery is discharged or the cutting pressure applied to the power tool is too high.	Change the battery and charge the empty battery. Reduce the feed pressure applied to the power tool.
The battery runs down more quickly than usual.	Very low ambient temperature.	Allow the battery to warm up slowly to room temperature.
The power tool does not restart by itself after the saw blade has stalled.	The overload cut-out has been activated.	Press the switch-on interlock and the on/off button again.
The battery doesn't engage with an audible double click.	The retaining lugs on the battery are dirty.	Clean the retaining lugs and push the battery in until it engages. Contact Hilti Service if the problem persists.
The power tool or the battery becomes very warm.	Electrical fault.	Switch the power tool off immediately, remove the battery from the tool and allow it to cool down while keeping an eye on it, contact Hilti Service.
	The power tool has been overloaded (application limits exceeded).	Use the right power tool for the job (don't use a low-powered tool for heavy work).
No / reduced suction power.	Chip ejector channel blocked.	Clean out the chip ejector channel.
The power tool switches itself off.	The overload/overheating cut-out has been activated.	Release the on/off switch and then press it again. Allow the system to cool down if necessary.
The pivoting guard doesn't close.	Dirt or dust.	Clean the parts and contact Hilti Service if the problem persists.

Fault	Possible cause	Remedy
The power tool vibrates strongly.	The saw blade is fitted incorrectly.	Fit the saw blade correctly. See section: 7.1.2 Fitting the saw blade <b>6</b>

## 10 Disposal

### CAUTION

Improper disposal of the equipment may have serious consequences: the burning of plastic components generates toxic fumes which may present a health hazard. Batteries may explode if damaged or exposed to very high temperatures, causing poisoning, burns, acid burns or environmental pollution. Careless disposal may permit unauthorized and improper use of the equipment. This may result in serious personal injury, injury to third parties and pollution of the environment.

### CAUTION

Dispose of defective batteries right away. Keep them out of reach of children. Do not disassemble or incinerate the batteries.

### CAUTION

Batteries that have reached the end of their life must be disposed of in accordance with national regulations or returned to Hilti.



Most of the materials from which Hilti power tools or appliances are manufactured can be recycled. The materials must be correctly separated before they can be recycled. In many countries, Hilti has already made arrangements for taking back your old power tools or appliances for recycling. Please ask your Hilti customer service department or Hilti representative for further information.



For EC countries only

Disposal of electric tools together with household waste is not permissible.

In observance of the European Directive on waste electrical and electronic equipment and its implementation in accordance with national law, electrical appliances that have reached the end of their life must be collected separately and returned to an environmentally compatible recycling facility.

## 11 Manufacturer's warranty - tools

Please contact your local Hilti representative if you have questions about the warranty conditions.

## 12 EC declaration of conformity (original)

Designation:	Cordless circular saw
Type:	SC 70W-A22
Generation:	01
Year of design:	2014

en

We declare, on our sole responsibility, that this product complies with the following directives and standards: 2006/42/EC, until 19th April 2016: 2004/108/EC, from 20th April 2016: 2014/30/EU, 2006/66/EC, 2011/65/EU, EN 60745-1, EN 60745-2-5, EN ISO 12100.

Hilti Corporation, Feldkircherstrasse 100,  
FL-9494 Schaan



**Paolo Luccini**  
Head of BA Quality and Process Management  
Business Area Electric Tools & Accessories  
09/2015



**Tassilo Deinzer**  
Executive Vice President  
Business Unit Power Tools & Accessories  
09/2015

### Technical documentation filed at:

Hilti Entwicklungsgesellschaft mbH  
Zulassung Elektrowerkzeuge  
Hiltistrasse 6  
86916 Kaufering  
Deutschland





Hilti Corporation

LI-9494 Schaan

Tel.: +423/234 21 11

Fax: +423/234 29 65

[www.hilti.com](http://www.hilti.com)

Hilti = registered trademark of Hilti Corp., Schaan  
Pos. 2 | 20150515



2092403